

TTP-243 Pro/ 243E Pro/ 342 Pro Series
TTP-243 Plus/ 243E Plus/ 342 Plus Series

**THERMAL TRANSFER / DIRECT THERMAL BAR
CODE PRINTER**

**USER'S
MANUAL**

CONTENTS

1. PRODUCT INTRODUCTION	2
1.1 Compliances.....	2
1.2 Effective Print Area.....	3
1.3 Available Bar Codes	3
1.4 Various Sensors	4
1.5 Supply Specifications	6
1.5.1 Types of Paper.....	6
1.5.2 Specifications	6
1.5.3 Ribbon Sizes and Shapes.....	8
2. GETTING STARTED.....	9
2.1 Unpacking and Inspection	9
2.2 Equipment Checklist.....	9
2.3 Printer Parts	10
2.4 External Label Roll Mount (Option for 243E series printer)	13
2.5 Buttons and Indicators.....	14
3. SET UP	15
3.1 Setting up the Printer.....	15
3.2 Loading Label and Tag Stock.....	16
3.3 Peel-off Function (Not available for 243E series printer).....	19
3.4 Ribbon Loading Instructions	22
3.5 Install External Label Roll Mount (Not available for 243E series printer)....	26
3.6 Install Memory Module (Option)	27
3.7 Self Test	29
3.8 Dump Mode.....	30
4. USING TTP-243 SERIES/243E SERIES/342 SERIES.....	31
4.1 Power-on Utilities	31
4.1.1 Self Test Utility.....	31
4.1.2 Gap Sensor Calibration Utility.....	31
4.1.3 Printer Initialization	32
4.2 Troubleshooting Guide	33
Update History.....	35

1. PRODUCT INTRODUCTION

Thank you very much for purchasing TSC TTP-243 series/ 243E series/ 342 series bar code printer. The attractive desktop printer delivers superior performance at an economical price. Both powerful and easy-to-use, this printer is your best choice among desktop direct thermal and thermal transfer label printers.

Printer offers both thermal transfer and direct thermal printing at selectable speeds of 1.5, 2.0 and 3.0 inches per second for TTP-243 series/ 243E series and 1.0, 1.5 and 2.0 inch per second for TTP-342 series. It can accept a wide range of media, including roll feed, die-cut, and fan-fold labels or tags for both thermal transfer and direct thermal printing. All of the most frequently used bar code formats are available. Fonts and bar codes can be printed in any one of four directions. This printer provides a choice of five different sizes of alphanumeric fonts. By using font multiplication, an even greater range of sizes is possible. Smooth fonts can be downloaded from the user-friendly Windows labeling design software. In addition, This printer is capable of independently executing BASIC programming functions, including arithmetic, logical operation, loop, flow-control and file management, among others. This programming capability provides the greatest efficiency in label printing.

TSC reserves the right to make changes in the product, the programs, and their availability at any time and without notice.

1.1 Compliances

CE Class A, FCC Class A, C-Tick Class A, TÜV/Safety, CCC

WARNING
1. HAZARDOUS MOVING PARTS IN CUTTER MODULE. KEEP FINGER AND OTHER BODY PARTS AWAY.
2. THE MAIN BOARD INCLUDES REAL TIME CLOCK FEATURE HAS LITHIUM BATTERY CR2032 INSTALLED. RISK OF EXPLOSION IF BATTERY IS REPLACED BY AN INCORRECT TYPE.
3. DISPOSE OF USED BATTERIES ACCORDING TO THE INSTRUCTIONS.

A급기기

(업무용 정보통신기기)

이 기기는 업무용으로 전자파 적합등록을 한 기기이오니, 판매자 또는 사용자는 이 점을 주위하시기 바라며, 만약 잘못 판매 또는 구입하였을 때에는 가정용으로 교환하시기 바랍니다.

1.2 Effective Print Area

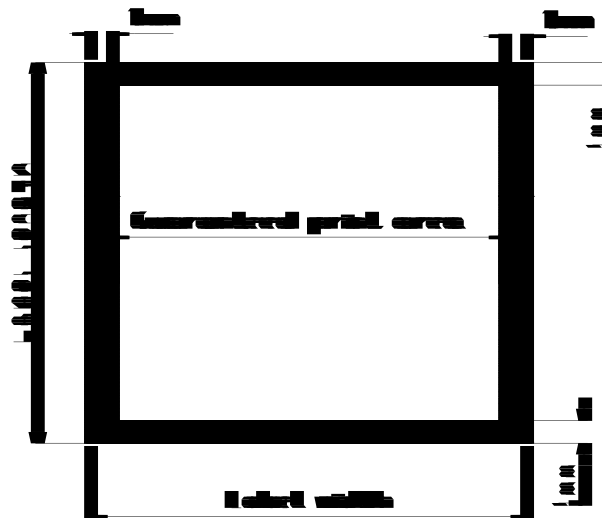

	203 DPI	300 DPI
Label/Ticket Print Length	12 mm~2286 mm	12 mm~1016 mm
Effective Print Length	10 mm~2284 mm	10 mm~1014 mm
Label/Ticket Print Width	25 mm~104 mm	
Effective Print Width	23 mm~102 mm	
No Print Area	1 mm	

1.3 Available Bar Codes

1D bar code

- Code 39
- Code 93
- Code 128 UCC
- Code 128, Subsets A, B, and C
- Codabar
- Interleaved 2 of 5
- EAN-8, EAN-13, EAN-128
- UPC-A, UPC-E
- EAN and UPC with 2 or 5 digits add-on
- MSI
- PLESSEY
- Postnet
- China post

2D bar code

- Maxicode
- PDF-417
- DataMatrix
- QR code
- GS1 DataBar family (RSS)

1.4 Various Sensors

Feed Gap Sensor

The feed gap sensor detects a label gap to locate the starting print position of the next label. The sensor is mounted 4 mm off the center line of the main mechanism.

In case of Label

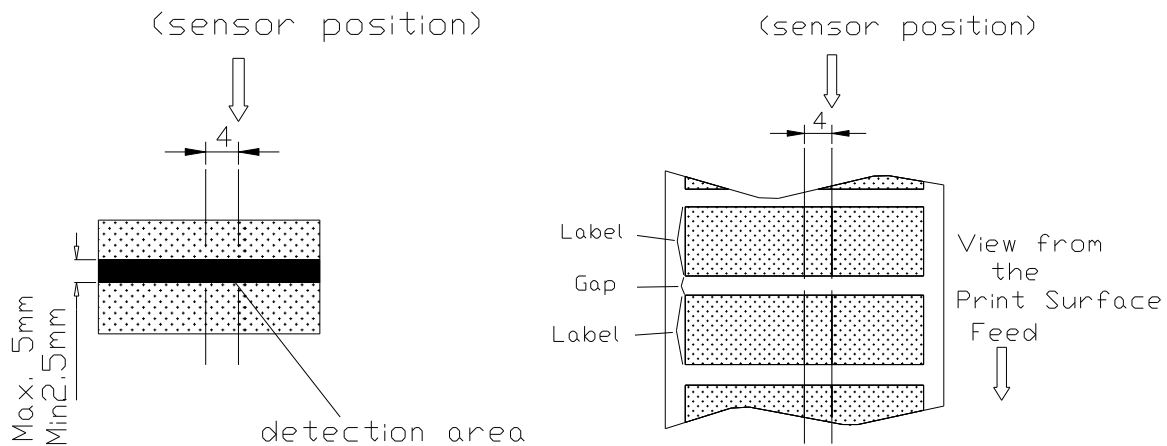

Black Mark Sensor

The black mark sensor locates the position of label by emitting infrared rays onto the black mark at the back of the ticket. The sensor is mounted 5.75 mm off the center line of the ticket roll width on the mechanism.

In case of Ticket

The default sensor position is (1) as shown on the figure below. To change to the (2) position, the customer should notify the manufacturer in advance. There can be only one position for the sensor. Once the sensor position is agreed upon, it can not be changed afterwards.

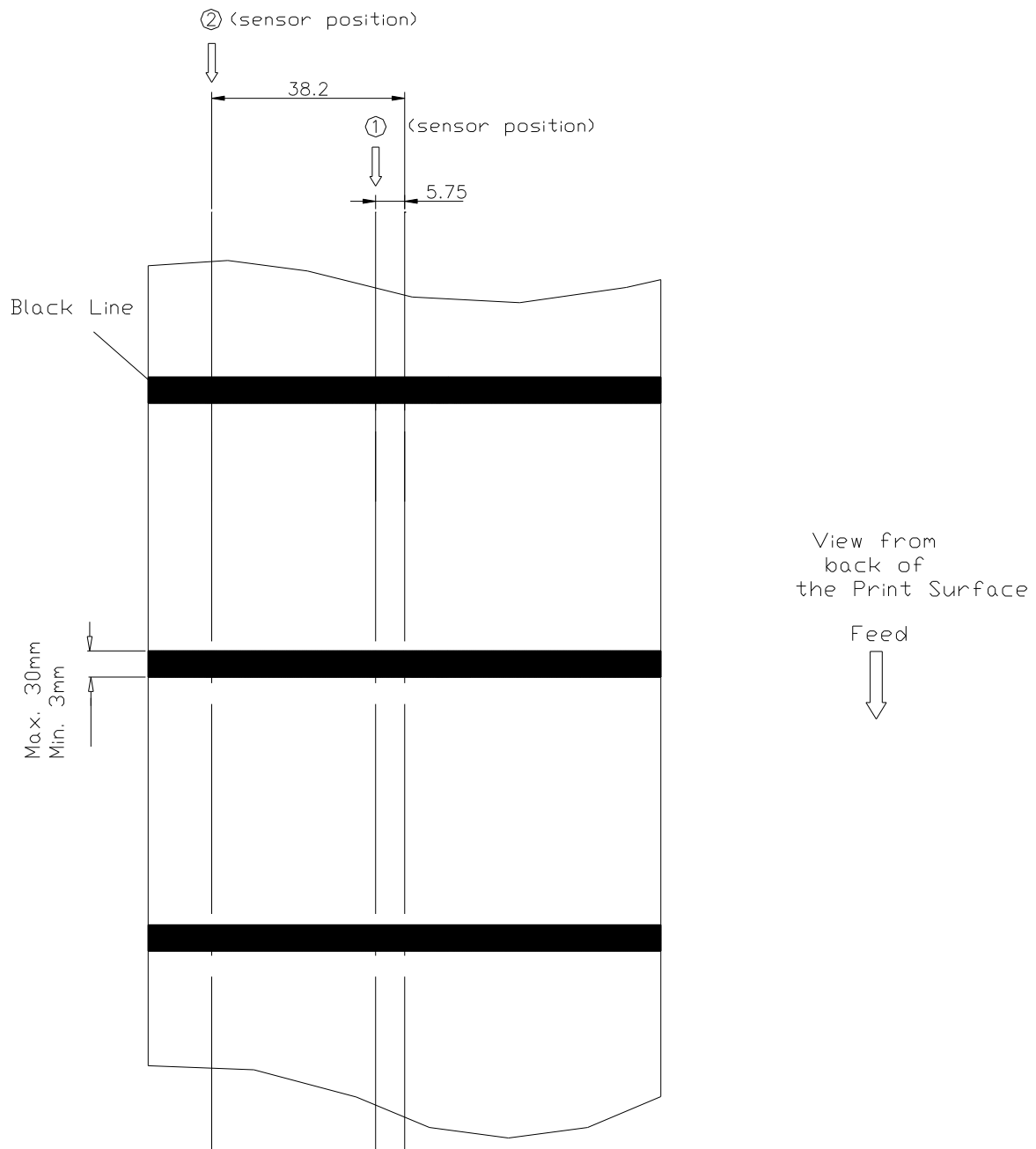

Ribbon End Sensor

The sensor detects the end portion of the ribbon. The ribbon end must be transparent.

Label End Sensor

The sensor detects the end portion of the label.

Peel off Sensor

The sensor detects the backing paper of a label.

Ribbon encoder

The encoder is used to detect if the ribbon is broken.

1.5 Supply Specifications

1.5.1 Types of Paper

Two types of media are available: label and ticket.

There are two types of sensors for paper: gap sensor and black mark sensor.

Label and ticket can be further classified into direct thermal type or thermal transfer type.

1.5.2 Specifications

Items	Label
Paper Width	Max. 114mm
	Min. 25mm
Length (Pitch)	12~2286mm
Paper Thickness	0.20 mm
Paper Weight	Max 240 g/m ²
Max. Roll Diameter (1" core)	Inner roll diameter. Max 4.3" (110mm)
	External roll diameter. Max 8.4" (214mm)
Roll Up Method	Print surface wound outside as standard
Paper Core ID.	φ25.7±0.3mm

Note:

- (1) The width and thickness quoted above are said of the label plus its backing paper.
- (2) Likewise, the approval of label entails that of its backing paper.
- (3) In the peel off mode, the minimum pitch is 35mm.
- (4) In the cutter mode, it is required the paper be wound outside. Otherwise, paper jam tends to result.
- (5) In the cutter mode, the paper thickness is 0.2 mm at maximum, and the paper weight is 100 g/m² at maximum.
- (6) Paper shape is as shown on next page.
- (7) Tag is 0.2mm in thickness, and is less than 100g/m² in weight.

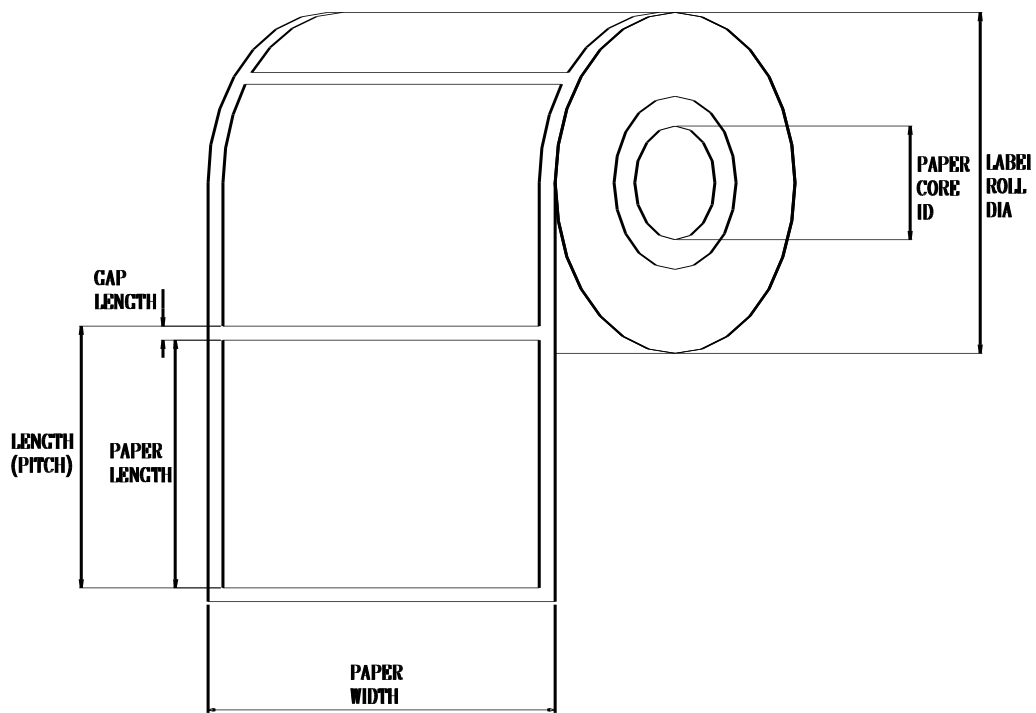

1.5.3 Ribbon Sizes and Shapes

Item	Specifications
Ribbon shape	Spool type
Ribbon width	Max. 110mm
	Min. 40mm
Ribbon winding width	Max. 110mm
	Min. 40mm
Leading tape	Polyester film, 335±5mm long
End tape	Polyester film (transparent), 250±5mm long
Max. ribbon OD.	φ67mm
Winding method	Ink surface to be wound outside

Note: The maximum length of ribbon depends on its thickness and core outside diameter.

The formula below defines the correlation between ribbon roll length and ribbon core diameter.

$$L = \frac{(D^2 - d^2) \times \pi}{4t}, \text{ where}$$

- L = Ribbon length
- D = Max. roll diameter
- d = Ribbon core outside diameter
- t = Ribbon thickness

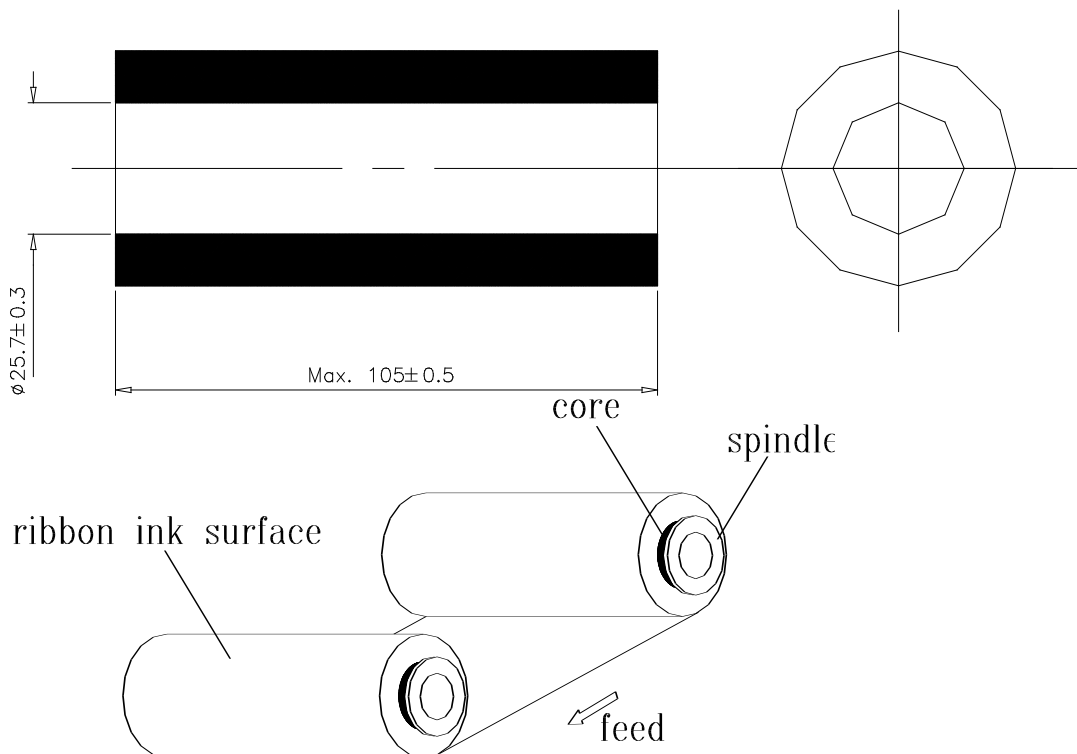

2. GETTING STARTED

2.1 Unpacking and Inspection

The printer has been specially packaged to withstand damage in the shipping process. However, for fear that unexpected damage might occur, upon receiving the bar code printer, carefully inspect the package and the device. In case of evident damage, contact the carrier directly to specify the nature and extent of the damage. Please retain the packaging materials in case you need to reship the printer.

2.2 Equipment Checklist

- One bar code printer unit
- One paper core for ribbon rewind spindle
- Two ribbon supply/rewind spindles
- One flat label supply roll spindle
- Two fixing tabs
- One round label supply roll spindle (Not available for 243E series printer)
- One Quick installation guide
- One Windows labeling software/Windows driver CD disk
- One power supply
- One power cord
- One USB interface cable (Pro series printer only)
- One Centronics interface cable (TTP-243 Plus & TTP-342 Plus series printer only)
- One sample roll of plain label stock (Not available for 243E series printer)
- One sample roll of wax-resin ribbon (Not available for 243E series printer)
- One external label roll mount (Not available for 243E series printer)

If any parts are missing, please contact the Customer Service Department of your purchased reseller or distributor.

2.3 Printer Parts

* Top front view

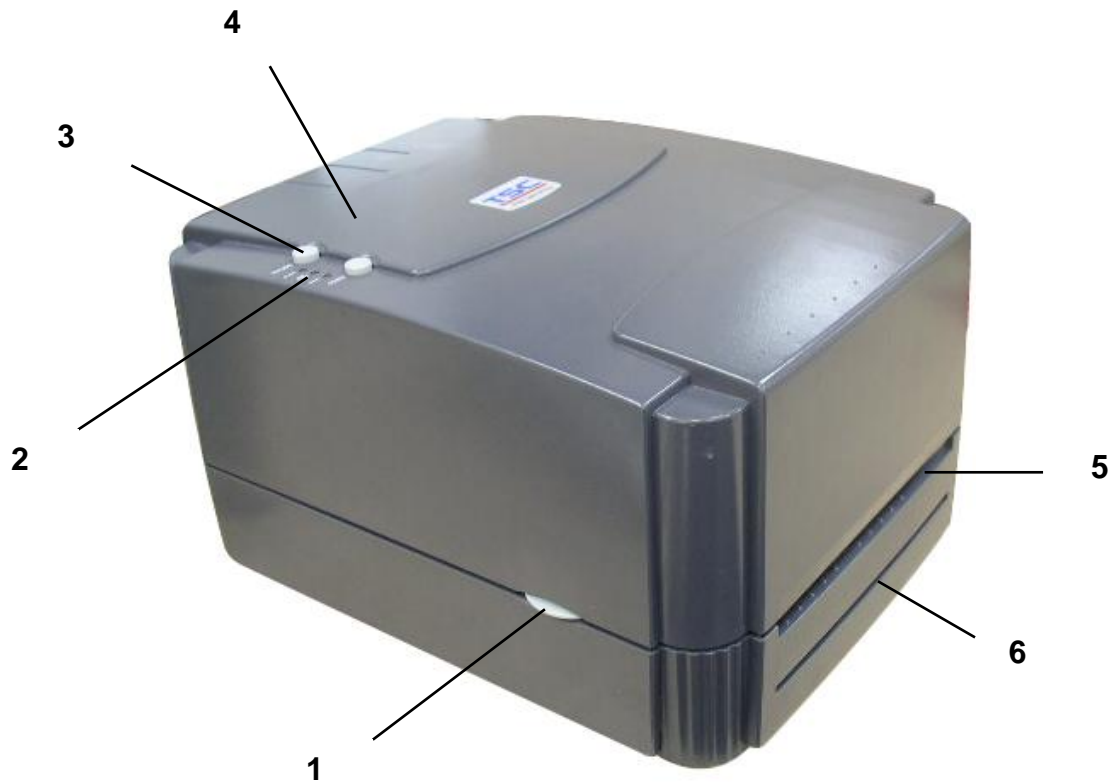

1. Cover Release Button
2. PWR., ON-LINE and ERR. Indicators
3. PAUSE Button
4. FEED Button
5. Label Dispense Opening
6. Liner Opening (For use with peel-off function/ Not available for 243E series printer)

* Interior view

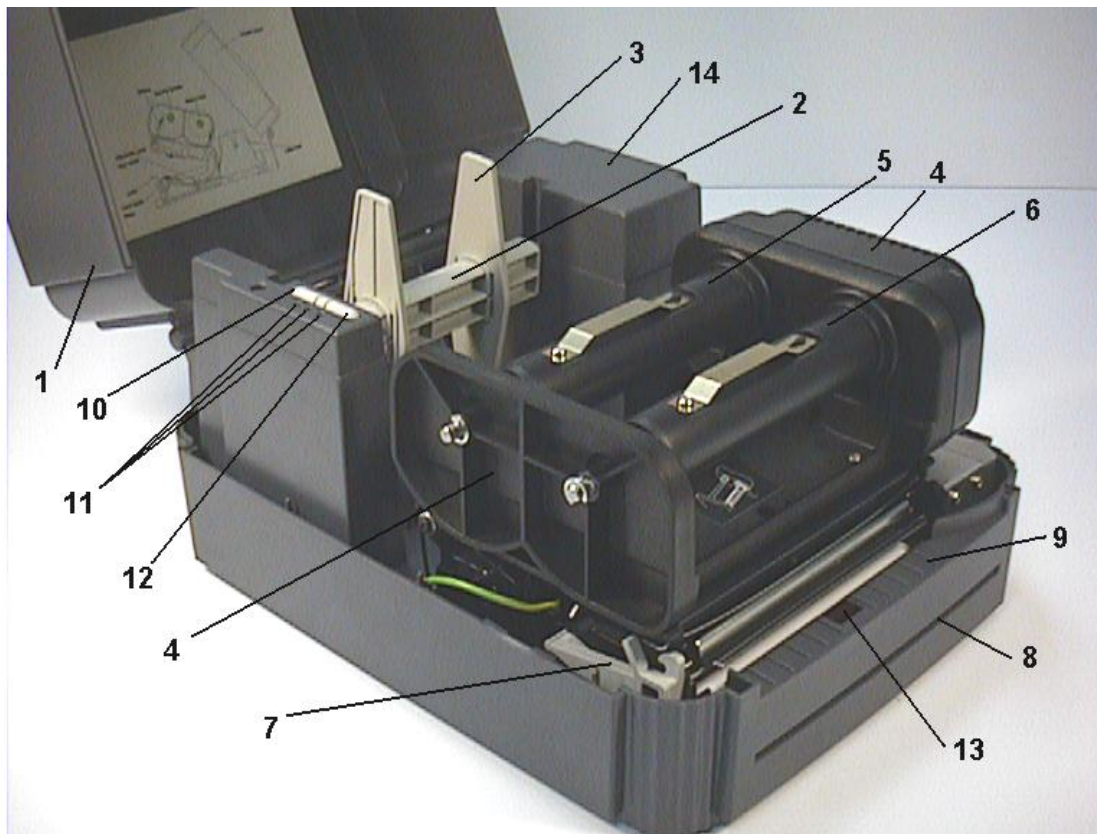

1. Printer Cover (In open position)
2. Label Supply Roll Spindle
3. Fixing Tabs
4. Ribbon Mechanism
5. Ribbon Supply Spindle
6. Ribbon Rewind Spindle
7. Printer Carriage Release Lever
8. Liner Opening
9. Detachable Front Panel
10. PAUSE Button
11. PWR., ON-LINE, ERR. Indicators
12. FEED Button
13. Peel-off Sensor (Not available for 243E series printer)
14. Memory Card Cover

* Rear view

TTP-243 Plus/ 243E Plus/ 342 Plus series

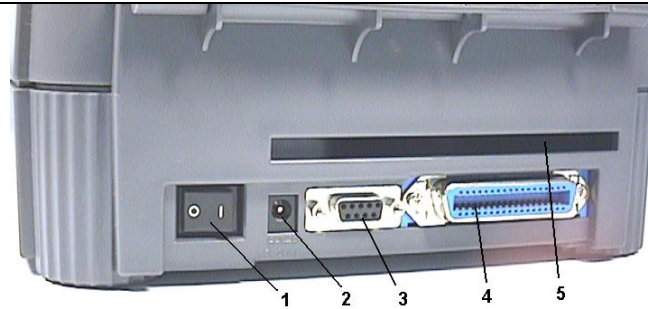

1. Power On/Off Switch
2. Power Supply Connector
3. RS-232C DB-9 Interface Connector
4. Centronics Interface Connector
5. Label Insert Opening (For use with external labels)

TTP-243 Pro/243E Pro/ 342 Pro series

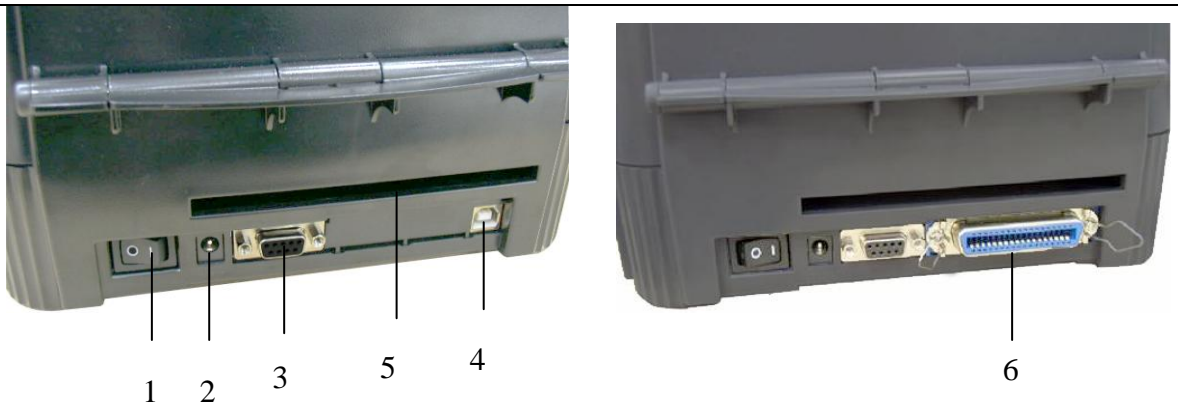

1. Power On/Off Switch
2. Power Supply DC Jacket
3. RS-232C Interface Connector
4. USB Interface Connector
5. Label Insert Opening (For use with external media)
6. Centronics Interface Connector (Factory option)

Note:

The interface picture here is for reference only. Please refer to the product specification for the interfaces availability.

2.4 External Label Roll Mount (Option for 243E series printer)



External label roll mount

2.5 Buttons and Indicators

PWR. (POWER) Indicator

The green **PWR.** indicator illuminates when the **POWER** switch is turned on.

ON-LINE Indicator

The green **ON-LINE** indicator illuminates when the printer is ready to print. When **PAUSE** button is pressed, the **ON-LINE** indicator flashes.

ERR. Indicator (Error/Paper Empty)

The red **ERR.** indicator illuminates in the event of a printer error, such as memory error, syntax error, and so forth. For a full list of error messages, please refer to section 4.2, Troubleshooting Guides.

PAUSE Button

The **PAUSE** button allows the user to stop a print job and then continue the printing with a second depression of the button. By pressing the **PAUSE** button: (1) the printer stops printing after the printing label, (2) the **PAUSE** LED flashes, and (3) the printer will hold all data in memory. This allows for trouble-free replacement of label stock and thermal transfer ribbon. A second depression of the **PAUSE** button will restart the printer.

Note: If the PAUSE button is held down for more than 3 seconds, the printer will be reset and all data of the previous printing job will be lost.

FEED Button

Press the **FEED** button to feed the label to the beginning of the next label.

3. SET UP

3.1 Setting up the Printer

1. Place the printer on a flat, secure surface.
2. Make sure the **POWER** switch is off.
3. Connect the printer to the computer mainframe with the provided RS-232C or Centronics cable.



4. Plug the power cord into the power supply connector at the rear of the printer, and then plug the power cord into a properly grounded receptacle.



Note: Please switch OFF printer power switch prior to plug in the power cord to printer power jack.

3.2 Loading Label and Tag Stock

1. Open the printer cover.
2. Disengage the printer carriage by pulling the printer carriage release lever on the left side of the platen.

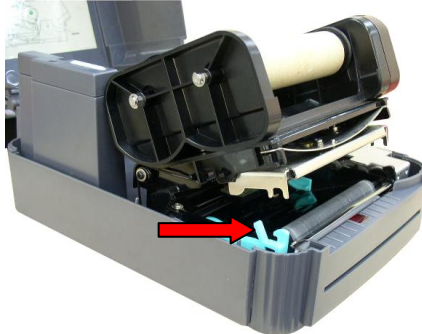

3. Slide the label supply roll spindle through the core of a label roll and attach the fixing tabs onto the spindle.



4. Place the label roll into the label roll mount. Feed the label under the carriage and over the platen.

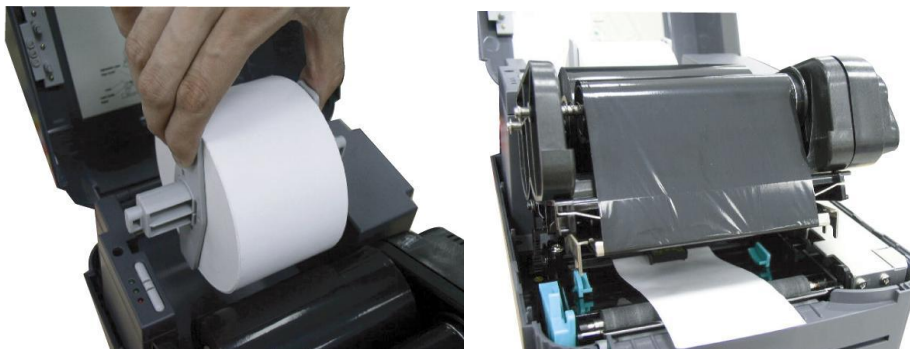

5. Adjust the label guide to fit the width of the media.

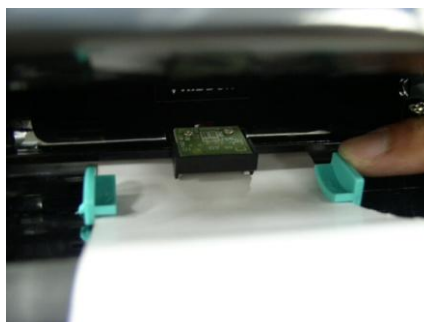

6. Engage the printer carriage.



7. Wind the label roll until it becomes adequately taut.
8. Close the printer cover and press the **FEED** button three or four times until the green **ON-LINE** indicator illuminates.
9. When the printer is out of ribbon or media, the **ON-LINE** LED will not illuminate and the **ERR.** LED will flash. Reload the ribbon or media without turning off the printer power. Press the **FEED** button three or four times until the **ON-LINE** LED illuminates. The printing job will be resumed without data loss.

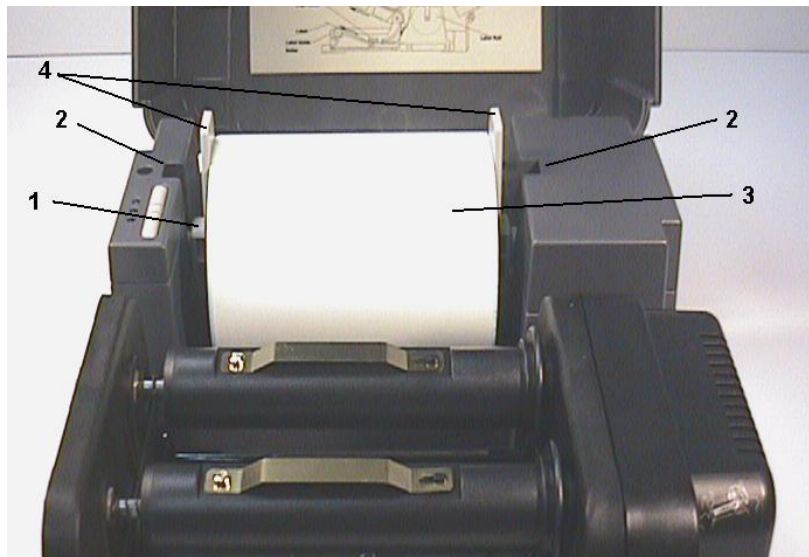

Inserting label supply roll into label roll mount

1. Label Supply Roll Spindle
2. Label Roll Mount
3. Label Roll
4. Fixing Tabs

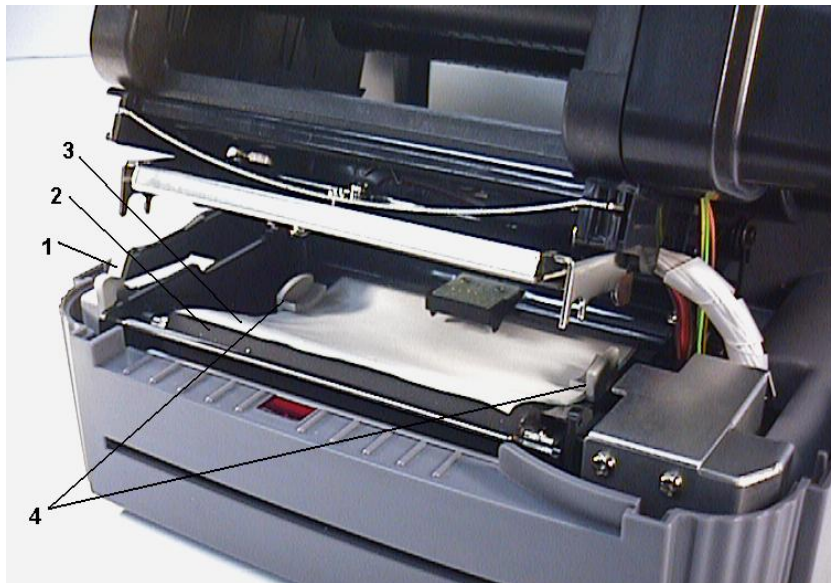

Feed labels through adjustable label guide

1. Printer Carriage Release Lever
2. Platen
3. Label Media
4. Adjustable Label Guide

3.3 Peel-off Function (Not available for 243E series printer)

To employ the peel-off function, load the label stock according to the following steps.

- 1. Remove the front panel.



- 2. Remove the foremost one or two labels from the liner.

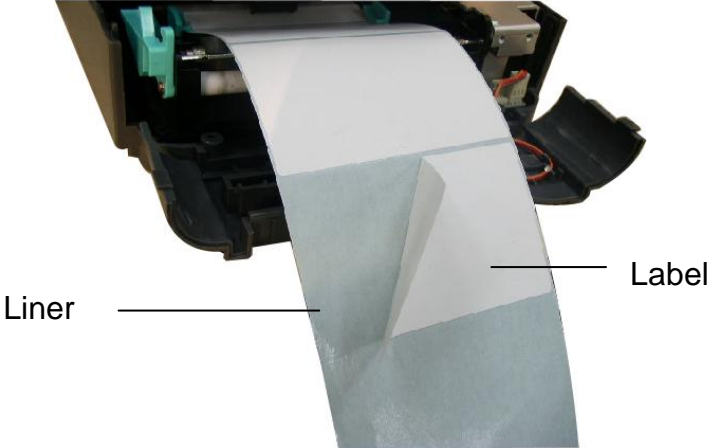

- 3. Pull the printer carriage release lever to feed the liner between the platen and the white peel-off roller.



- 4. Feed the liner through the liner opening in the front panel. Put back the front panel.

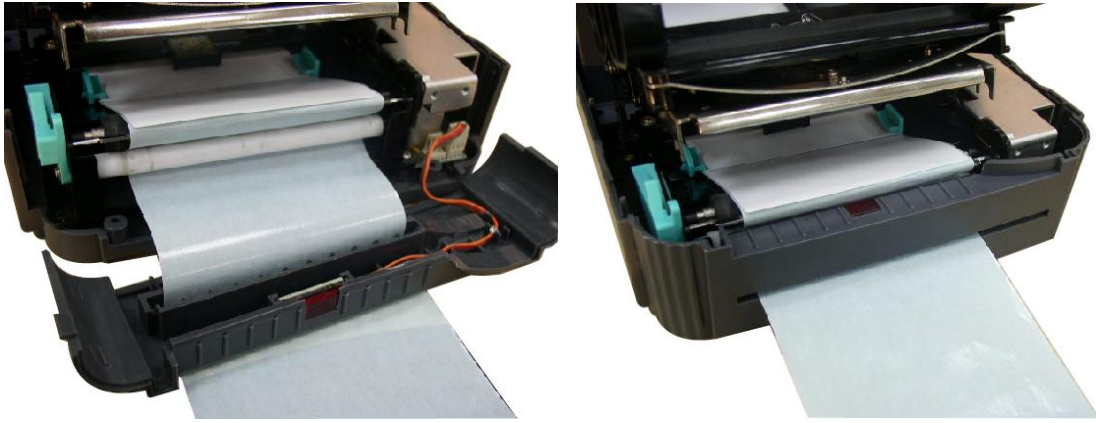

Note:

It is recommended that the print speed be set at 2 inches (1.5 inches for TTP-342 series) per second when using the peel-off function of the printer.

Peel-off function is not available for TTP-243E series printer.

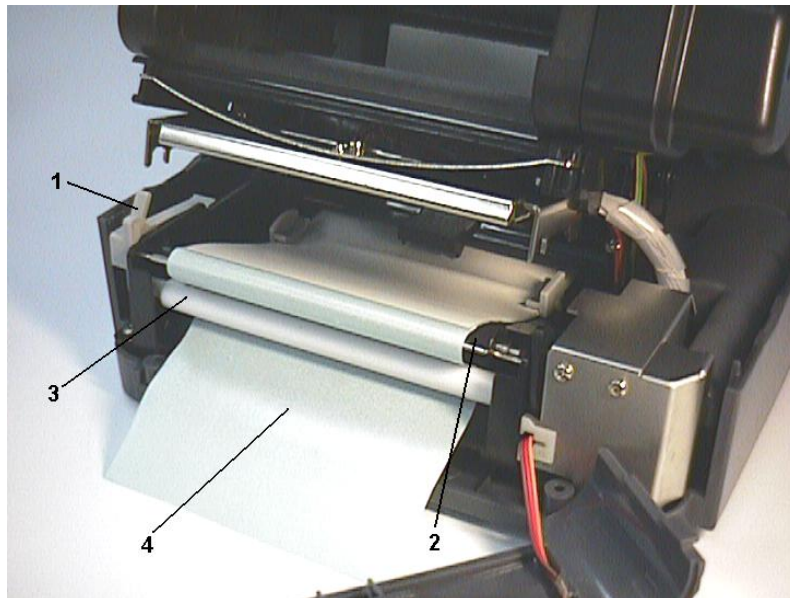

Setting up printer for peel-off function

1. Printer Carriage Release Lever
2. Platen
3. Peel-off Roller
4. Liner

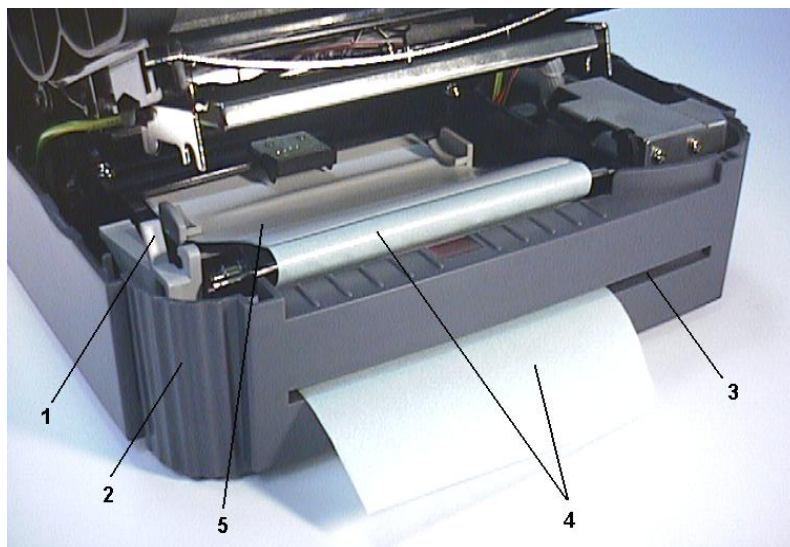

Printer ready for peel-off function

1. Printer Carriage Release Lever
2. Printer Front Panel
3. Liner Opening
4. Liner
5. Label

3.4 Ribbon Loading Instructions

1. Place an empty paper core on the ribbon rewind spindle.

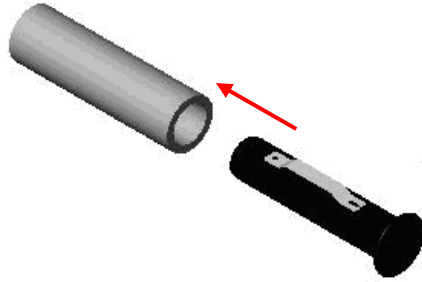

2. Insert the left side first. Mount the ribbon rewind paper core on the front hubs.



3. Please be noted that the bigger hub side with 4 ribs must be installed toward the right side of ribbon mechanism.



4. Install a ribbon on the ribbon supply spindle. Mount the ribbon supply spindle on the rear hubs.



5. Insert the left side first. Please be noted that the bigger hub side with 4 ribs must be installed toward the right side of ribbon mechanism.



6. Disengage the printer carriage by pulling the carriage release lever upwards.

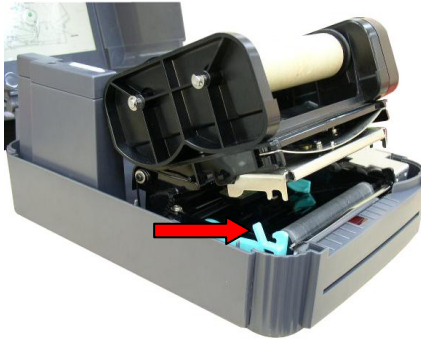

7. Following the direction of the ↓ **RIBBON** label, pull the transparent ribbon leader to the front from under the ribbon mechanism.



8. Attach the ribbon leader to the empty paper core on the ribbon rewind spindle (with a tape).

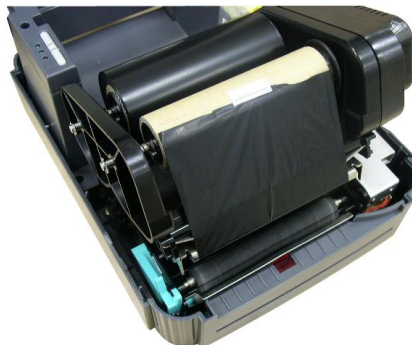

9. Rotate the ribbon rewind spindle until the ribbon overlaps the ribbon leader and stretches tight.



10. Engage the printer carriage.
11. Close the printer cover and press the **FEED** button until the green **ON-LINE** LED illuminates.

Note: Please install ribbon and media and close print head mechanism prior to turn on power. Printer will determine direct thermal or thermal transfer mode automatically while turning on printer power.



Placement of ribbon supply roll

1. Printer Carriage Release Lever
2. Ribbon Supply Spindle
3. Ribbon Rewind Spindle
4. Thermal Transfer Ribbon

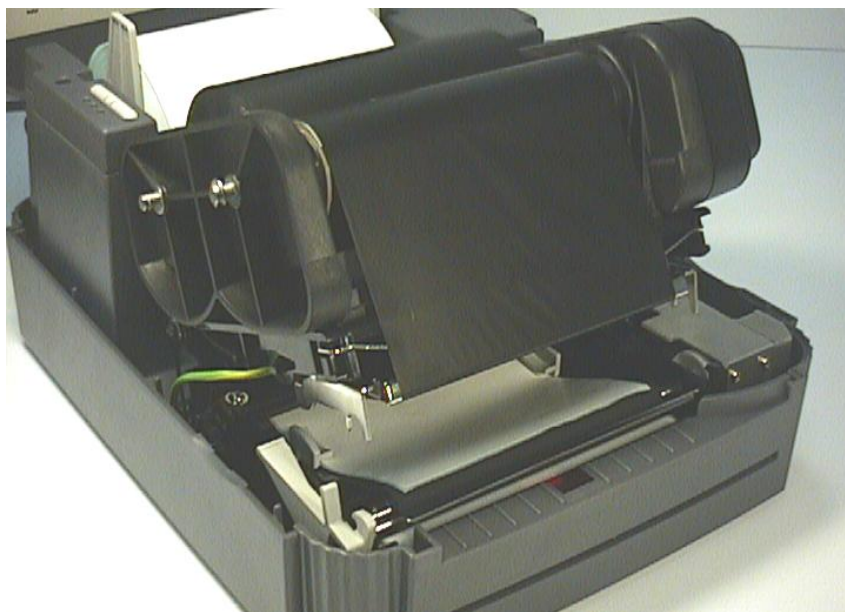

Installation of label stock and thermal transfer ribbon

3.5 Install External Label Roll Mount (Not available for 243E series printer)

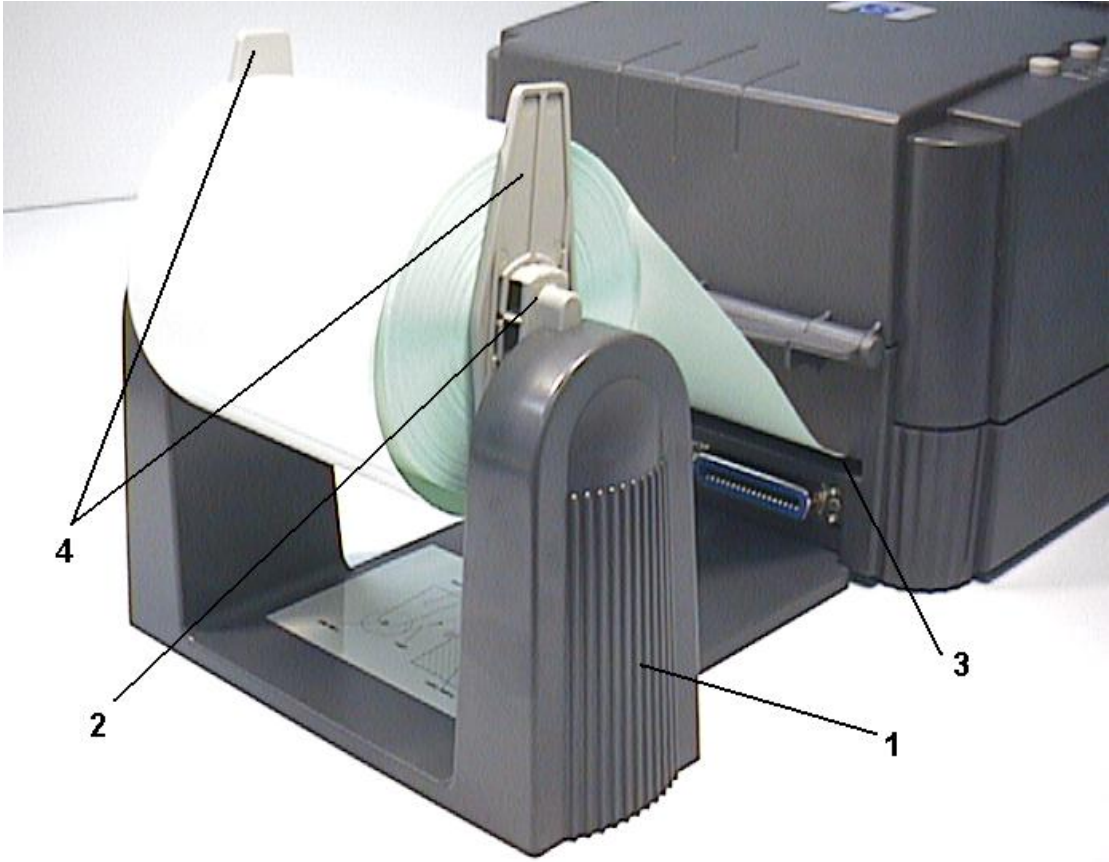

Installation of external label roll mount

- 1. External Label Roll Mount
- 2. Label Supply Roll Spindle
- 3. External Label Feed Opening
- 4. Fixing Tabs

3.6 Install Memory Module (Option)

1. Power off the printer.
2. Open the memory card cover.



3. Insert the memory module(Plus series) or Plus the SD memory card module(Pro series) on the main board.

TTP-243 Plus/243E Plus/ 342 Plus series	TTP-243 Pro/243E Pro/ 342 Pro Series

4. Close the memory card cover.
5. Turn on the power.

* Recommended SD card specification.

SD card spec	SD card capacity	Approved SD card manufacturer
V1.0, V1.1	128 MB	SanDisk, Transcend
V1.0, V1.1	256 MB	SanDisk, Transcend, Panasonic
V1.0, V1.1	512 MB	SanDisk, Transcend, Panasonic
V1.0, V1.1	1 GB	SanDisk, Transcend, Panasonic
V2.0 SDHC CLASS 4	4 GB	

V2.0 SDHC CLASS 6	4 GB	SanDisk, Transcend, Panasonic
V1.0, V1.1	microSD 128 MB	Transcend, Panasonic
V1.0, V1.1	microSD 256 MB	Transcend, Panasonic
V1.0, V1.1	microSD 512 MB	Panasonic
V1.0, V1.1	microSD 1 GB	Transcend, Panasonic
V2.0 SDHC CLASS 4	microSD 4 GB	Panasonic
V2.0 SDHC CLASS 6	microSD 4 GB	Transcend
V1.0, V1.1	miniSD 128 MB	Transcend, Panasonic
V1.0, V1.1	miniSD 256 MB	Transcend, Panasonic
V1.0, V1.1	miniSD 512 MB	Transcend, Panasonic
V1.0, V1.1	miniSD 1 GB	Transcend, Panasonic
V2.0 SDHC CLASS 4	miniSD 4 GB	Transcend
V2.0 SDHC CLASS 6	miniSD 4 GB	
<ul style="list-style-type: none"> - The DOS FAT file system is supported for the SD card. - Folders/files stored in the SD card should be in the 8.3 filename format - The miniSD/microSD card to SD card slot adapter is required. 		

3.8 Dump Mode

After the self-test, the printer enters the dump mode. In this mode, any characters sent from the host computer will be printed in two columns, as shown. The characters received will be shown in the first column, and their corresponding hexadecimal values, in the second. This is often helpful to users for the verification of programming commands or debugging of printer programs. Reset the printer by turning the **POWER** switch off and on for normal printing.

```
*****
NOW IN DUMP MODE

DOWNLOAD "DE 44 4F 57 4E 4C 4F 41 44 20 22 44 45
MO2.BAS" SI 4D 4F 32 2E 42 41 53 22 0D 0A 53 49
ZE 4.00,5.00 5A 45 20 34 2E 30 30 2C 35 2E 30 30
  CLS SPEED 0D 0A 43 4C 53 0D 0A 53 50 45 45 44
  1.5 DENSIT 20 31 2E 35 0D 0A 44 45 4E 53 49 54
Y 10 DIRECT 59 20 31 30 0D 0A 44 49 52 45 43 54
ION 0 SET C 49 4F 4E 20 30 0D 0A 53 45 54 20 43
UTTER OFF S 55 54 54 45 52 20 4F 46 46 0D 0A 53
ET DEBUG LAB 45 54 20 44 45 42 55 47 20 4C 41 42
EL REFERENC 45 4C 0D 0A 52 45 46 45 52 45 4E 43
E 0,0 A=100 45 20 30 2C 30 0D 0A 41 3D 31 30 30
0 Y=100 FO 30 0D 0A 59 3D 31 30 30 0D 0A 46 4F
R I=1 TO 3 52 20 49 3D 31 20 54 4F 20 33 0D 0A
BARCODE 100, 42 41 52 43 4F 44 45 20 31 30 30 2C
Y, "39",96,1, 59 2C 22 33 39 22 2C 39 36 2C 31 2C
0,2,4,STR$(A 30 2C 32 2C 34 2C 53 54 52 24 28 41
) A=A+1 Y= 29 0D 0A 41 3D 41 2B 31 0D 0A 59 3D
Y+150 NEXT 59 2B 31 35 30 0D 0A 4E 45 58 54 0D
PRINT 1 EO 0A 50 52 49 4E 54 20 31 0D 0A 45 4F
P DEMO2 50 0D 0A 44 45 4D 4F 32 0D 0A
```

4. USING TTP-243 series/243E series/342 series

4.1 Power-on Utilities

There are three power-on utilities to set up and test printer hardware. These utilities are activated by pressing the **FEED** or **PAUSE** button and turning on the printer power simultaneously. The utilities are listed as below:

1. Self-test
2. Gap sensor calibration
3. Printer initialization

4.1.1 Self Test Utility

Install the label first. Press the **FEED** button and then turn on the printer power. Do not release the **FEED** button until the printer feeds labels. The printer performs the following items:

1. Calibrate label pitch
2. Print out thermal print head check pattern
3. Print the internal settings
3. Enter dump mode

Regarding the self-test and dump mode, please refer to section 3.7 "Self Test" and section 3.8 "Dump Mode" for more information.

4.1.2 Gap Sensor Calibration Utility

This utility is used to calibrate the sensitivity of gap sensor. Users may have to calibrate the gap sensor for two reasons:

1. The media is being changed to a new type.
2. Initialize the printer.

Note: The ERR. LED may flash if gap sensor is not calibrated properly.

Please follow the steps below to calibrate gap sensor:

1. Turn off the printer power and install blank labels (without any logo or character) on printer.
2. Hold down the **PAUSE** button then turn on printer power.
3. Release **PAUSE** button when the printer feeds labels. **Do not turn off printer power** until the printer stops and two green LEDs light on.

Note: Black mark sensor has fixed sensitivity. It is no need to calibrate the black mark sensor

4.1.3 Printer Initialization

Printer initialization clears all downloaded files resident in flash memory, and sets printer parameters to default values.

Parameter	Default Value
Speed	200 dpi: 50.8 mm/sec (2 ips) 300 dpi: 38.1 mm/sec (1.5 ips)
Density	8
Label Width	4"(101.6 mm)
Label Height	4"(101.6 mm)
Sensor Type	Gap sensor
Gap Setting	0.12" (3.0 mm)
Print Direction	0
Reference Point	0,0 (upper left corner)
Offset	0
Tear Mode	On
Peel off Mode	Off
Cutter Mode	Off
Serial Port Settings	9600 bps, none parity, 8 data bits, 1 stop bit
Code Page	850
Country Code	001
Clear Flash Memory	Yes

Please follow the steps below to initialize the printer:

1. Turn off the printer power.
2. Hold down the **PAUSE** and **FEED** buttons and turn on the printer power.
3. Do not release the buttons until the three LEDs flash in turn.

Note 1: Printing method (thermal transfer or thermal direct printing) will be set automatically at the activation of printer power.

Note 2: When printer initialization is done, please calibrate the gap sensor again.

Note 3: Download files will be deleted after printer initialization.

4.2 Troubleshooting Guide

The following guide lists some of the most common problems that may be encountered when operating the bar code printer. If the printer still does not function after all suggested solutions have been invoked, please contact the Customer Service Department of your purchased reseller or distributor for assistance.

Problem	Solution
Ribbon does not advance or rewind	<ol style="list-style-type: none"> 1. The media and ribbon must be installed then engage the print head mechanism prior to turning on printer power. 2. Install the black ribbon spindle at the correct direction. 3. Please check the "Media settings method" in the driver if it is set to direct thermal mode.
Poor print quality	<ol style="list-style-type: none"> 1. Clean the thermal print head. 2. Adjust the print density setting. 3. Ribbon and media are not compatible. 4. Media thickness is over spec. 5. Check if correct power supply is connected with printer.
Power indicator on printer does not illuminate	<ol style="list-style-type: none"> 1. Check the power cord, see whether it is properly connected. 2. Check if the LED on the power supply is illuminated. If it is not lit on, then the power supply is damaged. 3. Check if correct power supply is connected with printer.
ON-LINE indicator is off, ERR. indicator is on	<ol style="list-style-type: none"> 1. Out of paper or out of ribbon If there is one beep sound when printer is error, then it's gap sensor problem. Please check the following items. <ol style="list-style-type: none"> (1) Calibrate gap sensor or setup the paper length in labeling software/program properly. (2). Install the paper at the correct If there are two beeps sound when printer is error

	<p>then it's ribbon sensor problem. Please check the following items.</p> <p>(1) Is outside wound ribbon is used with this printer?</p> <p>(2) Is ribbon threaded correctly in the mechanism?</p> <p>(3) Is paper core installed on the ribbon take up spindle?</p> <p>2. Calibrate the sensitivity of gap sensor.</p>
<p>Continuous feeding when printing labels</p>	<p>1. Check the driver or command script setting if sensor type is set properly.</p> <p>2. Calibrate the gap sensor again if die cut media is used for printing.</p>

Update History

Date	Content	Editor
2010/10/12	Add section 1.2~1.5	Camille
2010/10/13	Modify section 1.2 & 1.3	Camille
2010/11/22	Modify section 1.1	Camille
2011/1/25	Modify TSC address	Camille



TSC Auto ID Technology Co., Ltd.

Corporate Headquarters

9F., No.95, Minquan Rd., Xindian Dist.,
New Taipei City 23141, Taiwan (R.O.C.)

TEL: +886-2-2218-6789

FAX: +886-2-2218-5678

Web site: www.tscprinters.com

E-mail: printer_sales@tscprinters.com

tech_support@tscprinters.com

Li Ze Plant

No.35, Sec. 2, Ligong 1st Rd., Wujie Township,
Yilan County 26841, Taiwan (R.O.C.)

TEL: +886-3-990-6677

FAX: +886-3-990-5577